

## The new Juventus Stadium in Turin

### Massimo MAJOWIECKI

Professor  
IUAV University  
Venice, ITALY  
*massimo.majowiecki@majowiecki.com*

Massimo Majowiecki, born 1945, received his civil engineering degree from the University of Bologna. Actually is Professor of Structural Architecture in IUAV, University of Venice

### Francesco OSSOLA

Professor  
Politecnico di Torino  
ITALY  
*info@studio-ossola.it*

Francesco Ossola, born 1947, received his civil engineering degree from the Polytechnic of Turin, Italy. He is a tenured professor at the pPolytechnic of Turin in Construction Ergotechnics.

### Stefano PINARDI

Civil Engineer  
Studio Tecnico Majowiecki  
Casalecchio di Reno (BO),  
ITALY

*stefano.pinardi@majowiecki.com*

Stefano Pinardi, born 1966, received his civil engineering degree from the University of Bologna, Italy. He works for Studio Tecnico Majowiecki, Casalecchio di Reno (BO) Italy

## Summary

After about 19 years the “delle Alpi” Stadium of Turin (Italy), builded for Italia '90 WorldCup is going to be substituted by a new stadium named “Nuovo Stadio Juventus” designed according newer and actual guidelines for stadium and sport's arena utilization.

Scope of this paper is to show the adopted architectural and structural design approach

The paper illustrates principally:

- 1) foundation system;
- 2) grand stand frames;
- 3) suspended roof structural system;

The design has been assisted by experimental testing procedures in boundary wind tunnel laboratories.

**Keywords:** Sport Arena, Soccer Stadium, New Juventus Stadium, suspended steel roof, experimental testing in boundary wind tunnel

## 1 Introduction: description of structural design

Structural solution is characterized by a suspended steel roof with stays appended to two-legs post at each side and grand stand system (with concrete frames until level +18.55m and steel frames for the higher level until the external roof supports (+33.00m)).

### 1.1 Foundations system

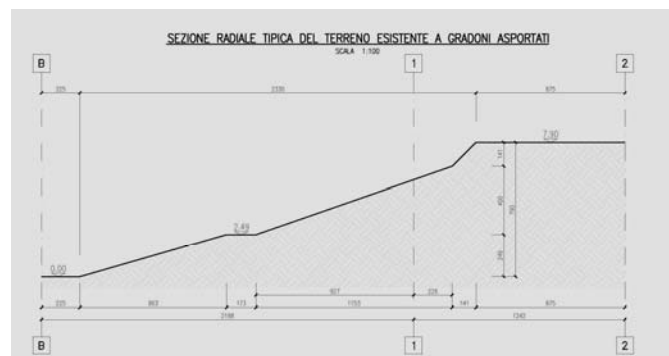
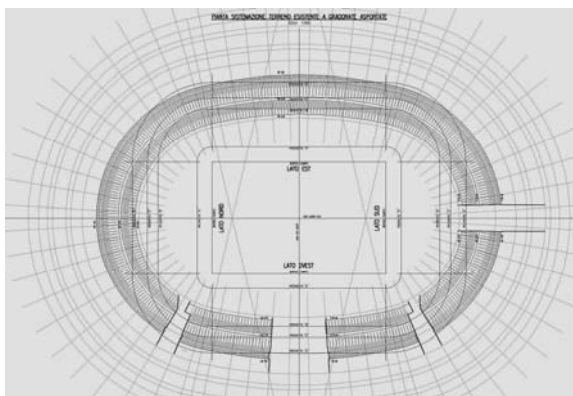

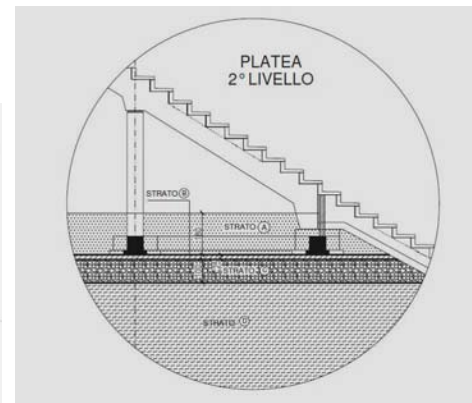
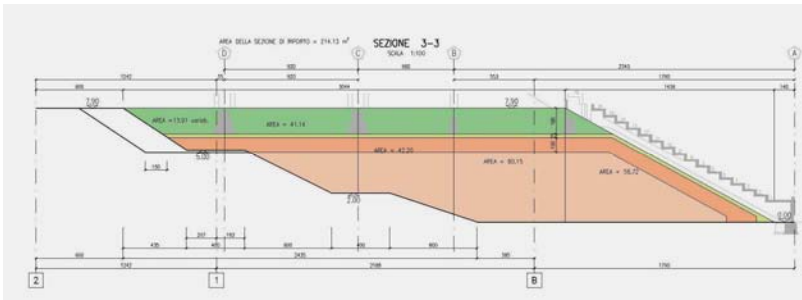

The foundation system is based on a texture of direct beams foundation on ground stratification with different characteristics:

- Layer D: is made up to 1.30 m below the foundation beams and must have a low ductility;
- Layer B and C: respectively have a thickness of 0.30 m and 1,00 m. The level B have stricter requirements regarding the size of materials.
- Layer A: is the last one layer, where the flooring laying.

There is also another type of foundation, the deepest one, make with jet grouting columns.

This foundation is built to anchor the six stay cables of the cover, the foundation is placed outside the stadium, has two parts: one consisting in two deep wells made of jet grouting columns and a concrete block in the upper level.

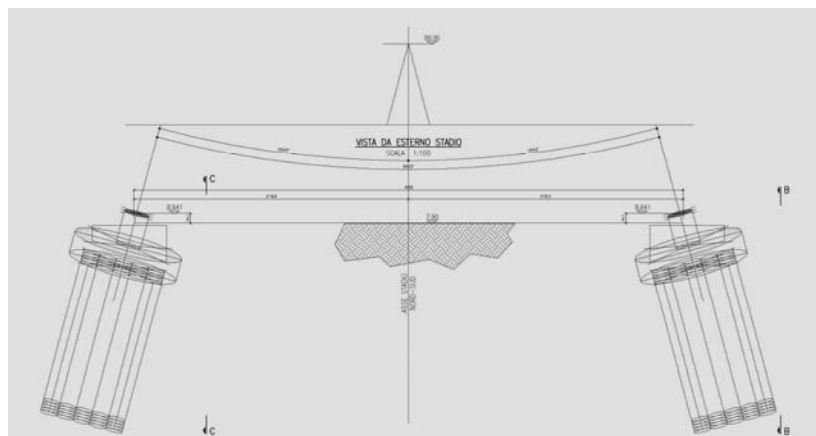
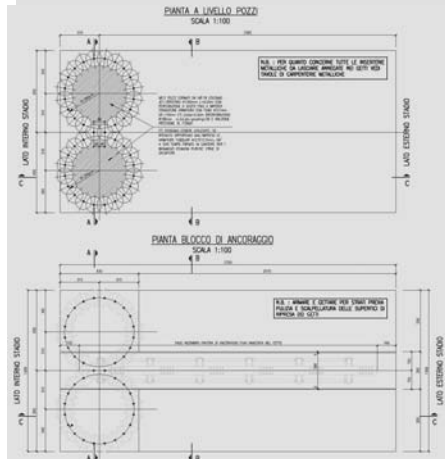
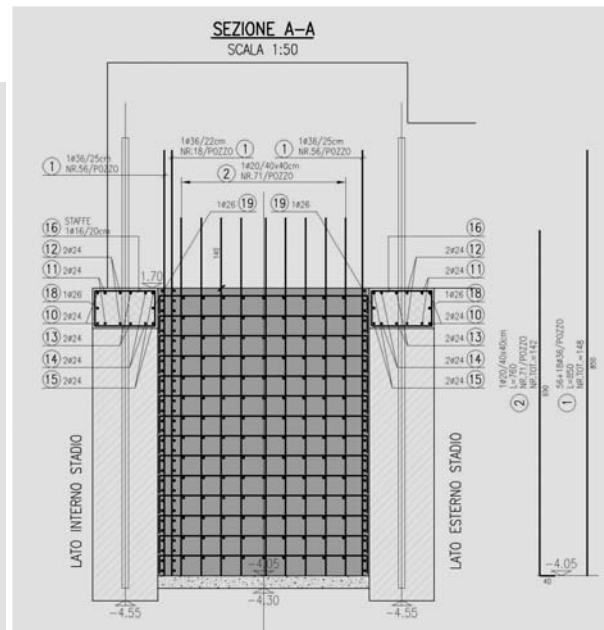
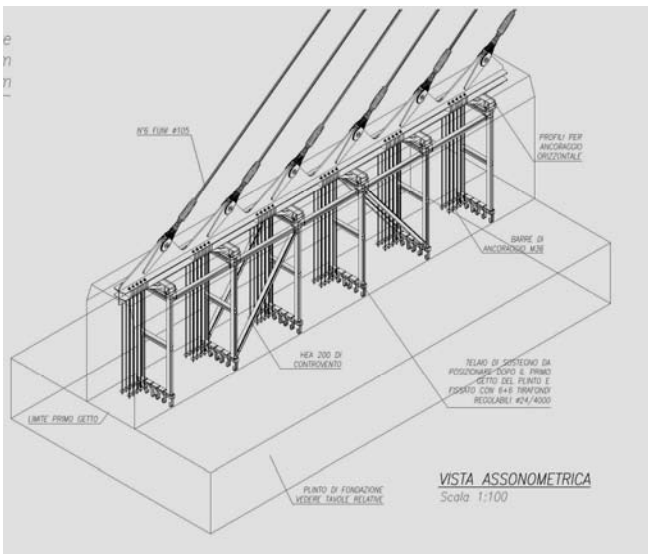

These are the foundations of the two legs main columns, are made with two deep wells made of jet

grouting columns

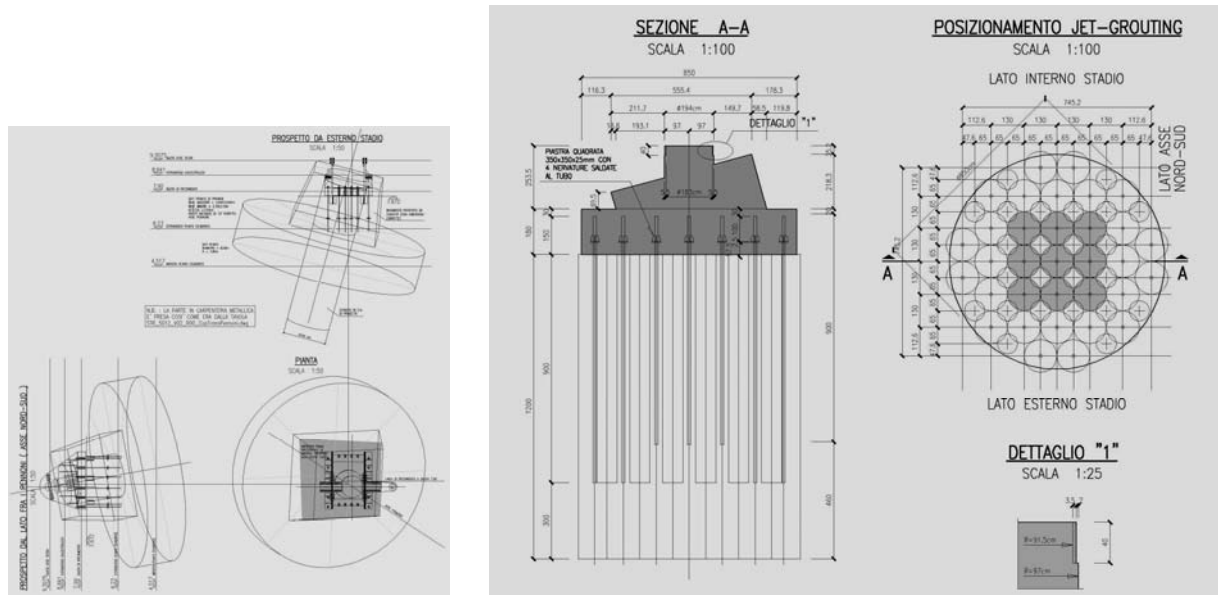

## 1.2 Grand stand frames

Lower level grand stands have concrete frames connected by rigid slabs and separated by seismic and thermal joints. Higher level steel grand stands have columns and beams with box section made by welded plates. Detailed analysis are developed to define the geometry (“T” or “L” shape depending by the span) of stand to avoid annoying vibrations for the human comfort.

Thanks to low seismicity of the place, seismic design has adopted a structure factor  $q = 1$ .

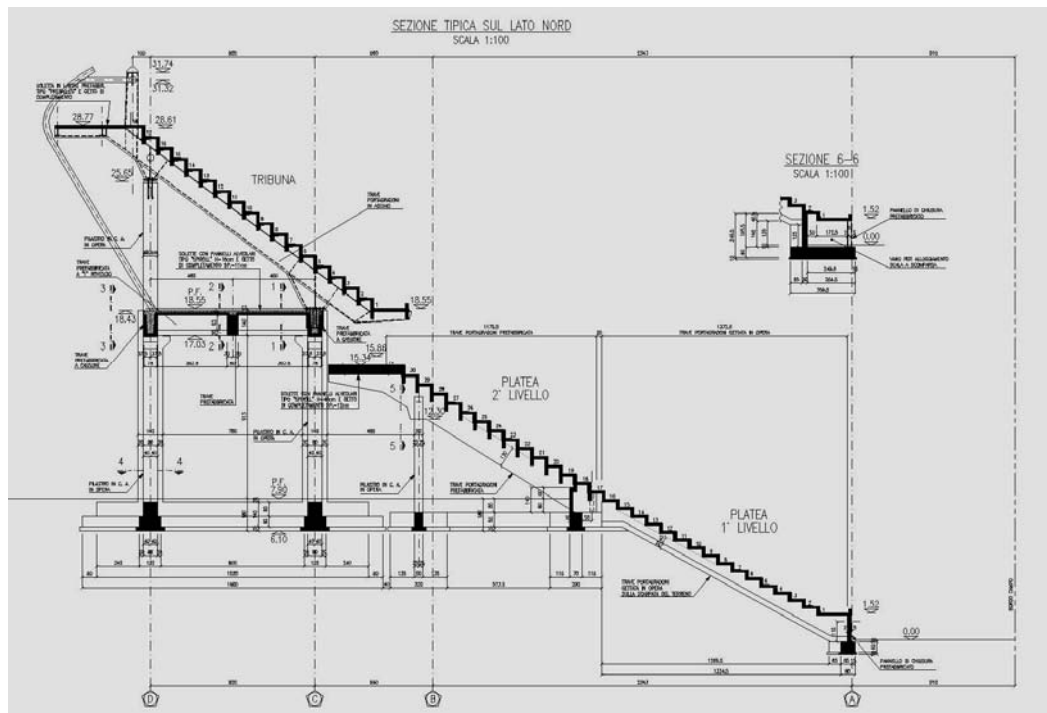

## 1.3 Roof structure

Roof structure is composed by the suspended main structure and secondary reticular trusses.

### 1.3.1 Suspended main structure

Two couples of main trusses form the rectangular inner edge of the roof over the playfield limits.

At the four intersection joints a system of 4 stay cables ( $\phi 105\text{mm}$ , about 93m length) suspend the main structure at the heads of two main columns. Each head is then anchored to ground by a system



of 6 stay cables ( $\phi 105$ , about 128m length).

Main truss spans are 125m and 88m respectively with one top chord and two bottom chords. The top chord is straight, the bottom chords is curved so the height changes along the span. In the middle span main truss is about 7.3m height and 5.3m width.

Top and bottom chords have cross-section made by welded plates with thickness variable from 25mm to 40mm.

Post and diagonal members of main trusses is formed by CHS elements with 300mm diameter and bolted to chords. CHS transverse elements connect the joints of the two bottom chords.

Main column has a “inverted V” shape, is 56m height and it is formed by two legs 84m length.

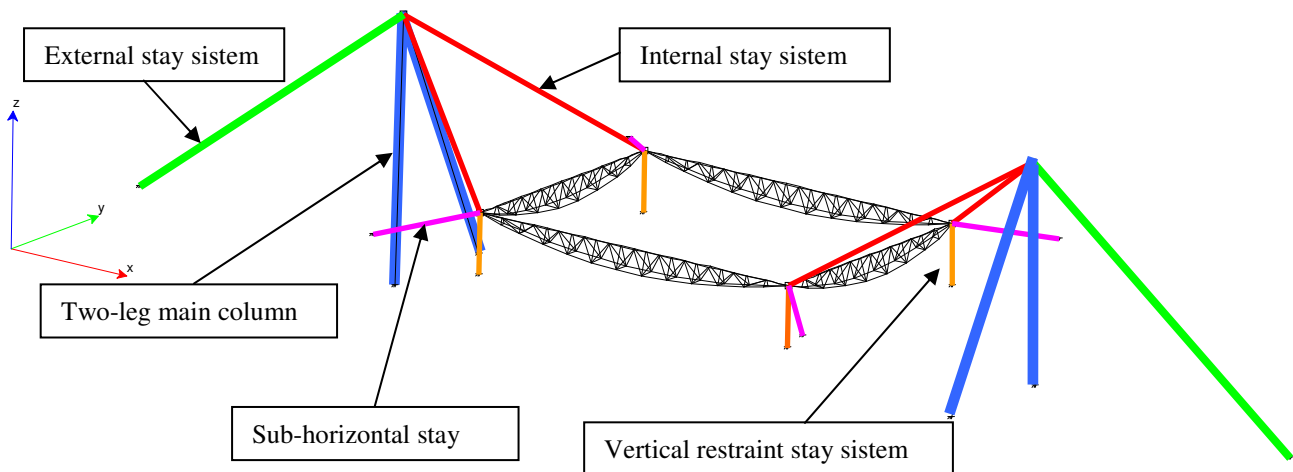

Each leg of main column has tapered shape. Cross section shape is triangular formed by 3 curved plates 30/35mm thick. In the middle span the triangle side is about 3.75m length.

An internal system of transverse and longitudinal ribs stiffens the curved plates.

The head of main column has a main plate to connect the external stay system and a saddle to deviate the cables of the internal stay system.

The foot of each leg is designed as a spherical hinge with a forged steel sphere with 500mm radius.

To ensure the stability of the main structure respect to uplifting and dragging wind action the 4 main nodes are anchorate to the ground and to the main grand stands with a vertical restraint stay and a sub-horizontal stay respectively.

A prestress field is put into the stay systems to ensure the necessary stiffness and the bi-lateral functionality. In order to reach this goal each cables has at least one adjustable terminal.

### 1.3.2 Secondary roof trusses

Along inner roof edge formed by main trusses and the outer edge formed by the top of the grand stand frames are placed the secondary trusses with about 11 m step. Each truss has a span of about 40m and has one straight bottom chord and two curved top chords. Internal height at mid span is about 2.60m.

Each couple of secondary trusses is connected at mid span by a reticular transverse to ensure lateral stability and a quick mounting procedure.

Between trusses is placed the steel sheeting with a alternated empty-full 1:1 pattern. In order to support the design loads with a span of 11m, 160mm height sheetings are composed to create a cellular box of double height.



To define correctly the sheeting characteristics (height, thickness and any supplementary ribs) and the composing pattern of cellular boxes, a set of real tests is planned according to Eurocode 0 (“Design assisted by testing”).

Finally, a covering composite membrane is placed over the discontinuous sheeting layer.

## 2 Mathematical models and analysis

### 2.1 Main structures and secondary trusses

Main structures and secondary trusses are modeled with 3D mathematical models suited for linear and non-linear static analysis and dynamic analysis.

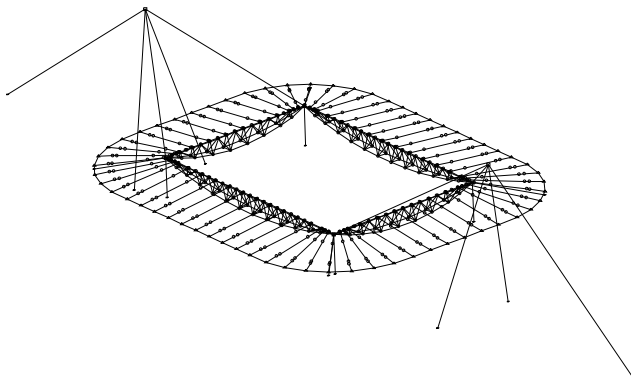

Main structures - Isometric view

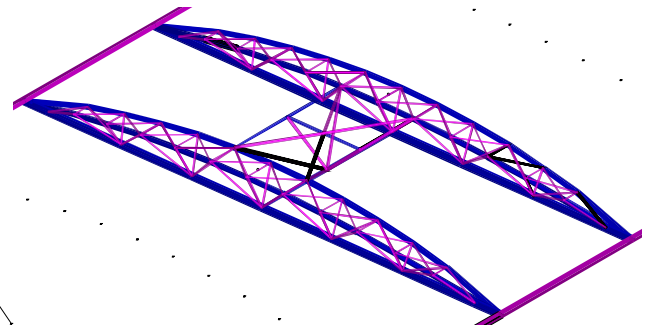

Secondary trusses – Isometric solid view

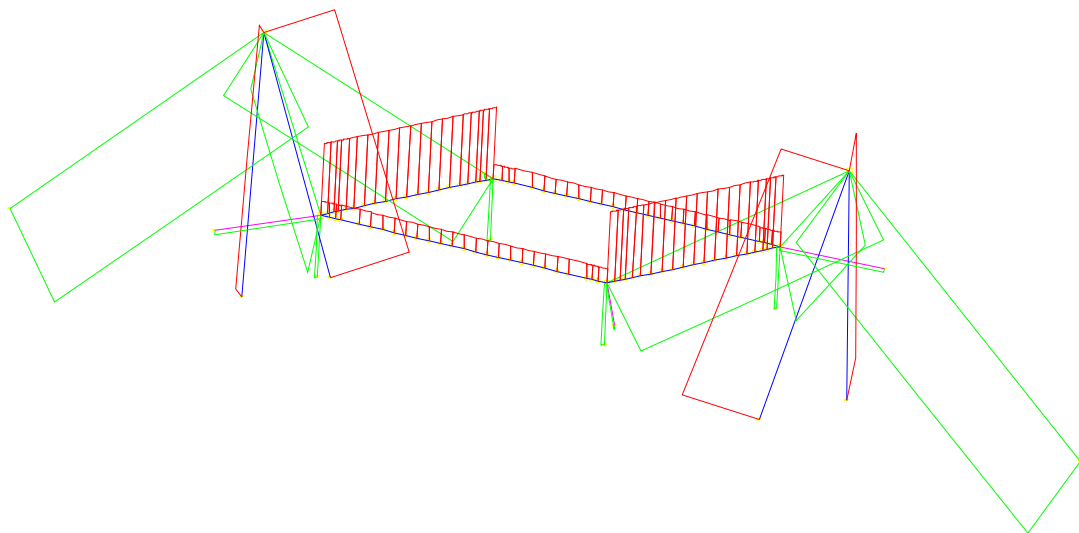

Axial forces field in the main suspended system (red = compression, green = tension)

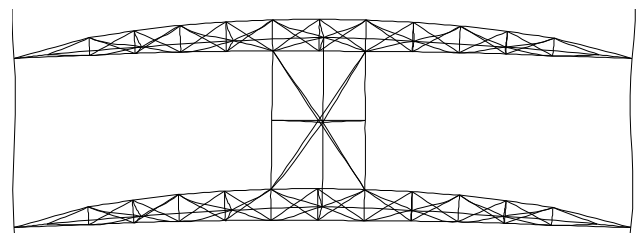
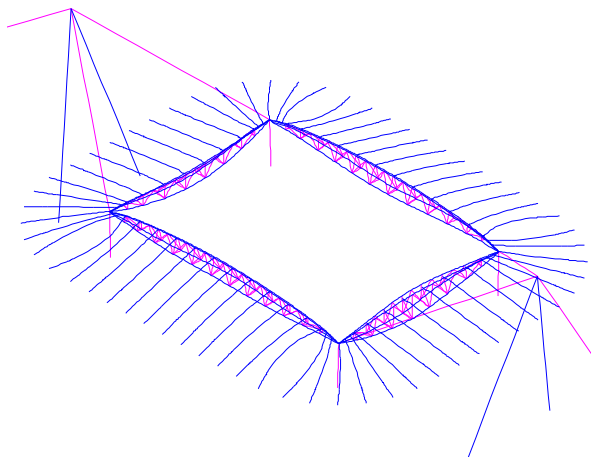

Some modal shapes



## 2.2 Main columns

Each main column is modeled as an element with variable cross section. It is subjected to its self-weight, to axial force derived from main suspension system and to wind action.

The analysis of resistance and stability has followed these steps (according to EN1993-1-1):

- 1) determination of buckling factor of column;
- 2) determination of design imperfections and updating of mathematical model according this deformed shape oriented such to have imperfection effects with same sign of external actions effects;
- 3) analysis of response of the column to the design actions taking in account the geometric non-linearity effects;
- 4) check cross sections resistance assuming Class 3 according EN1993-1-1;
- 5) design of longitudinal and transversal ribs according EN1993-1-5.

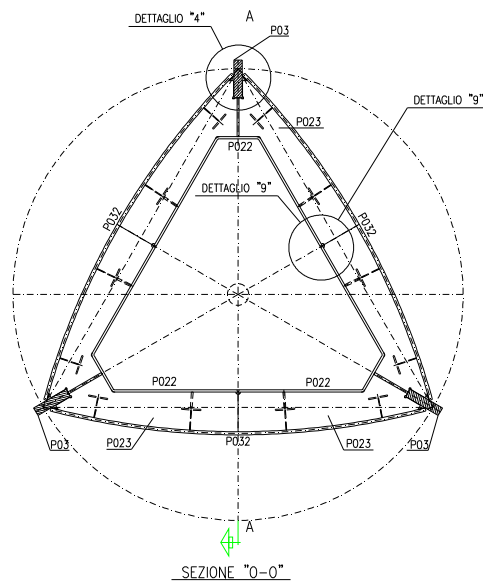

Typical cross section

## 2.3 Main suspending joint

Special attention is dedicated to the analysis of main suspending joint. A dedicated 3D FEM mathematical model is implemented to analyze the stress diffusion and their peaks.

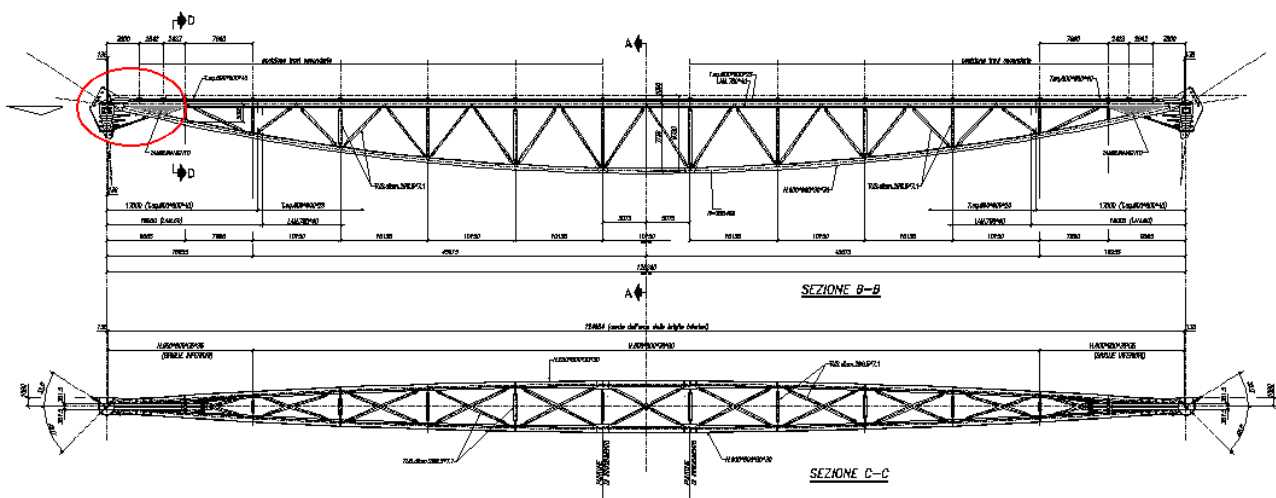

Main truss with terminal suspending joint

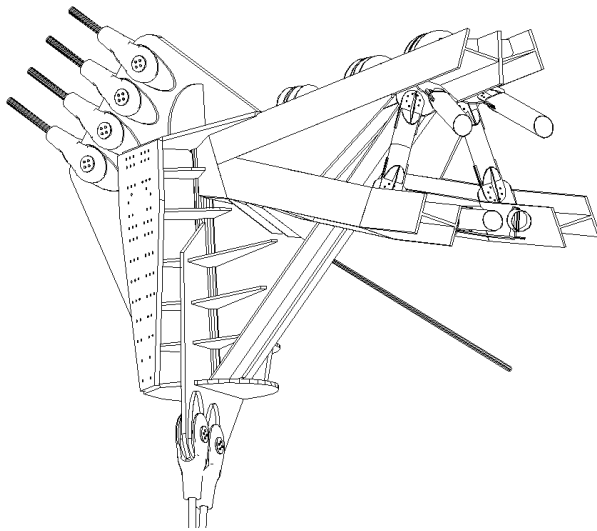

solid view drawing

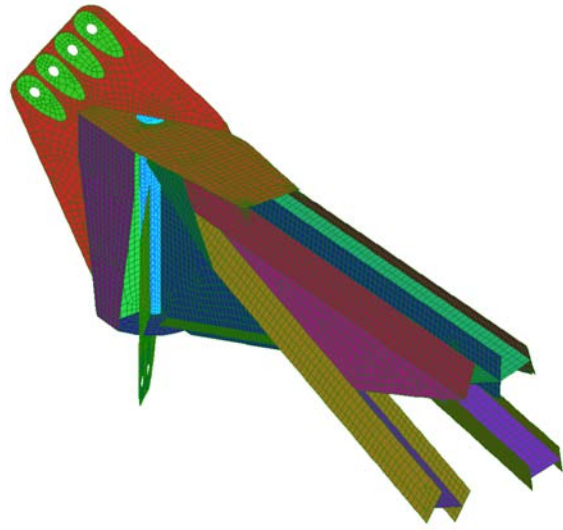

3D FEM mathematical model

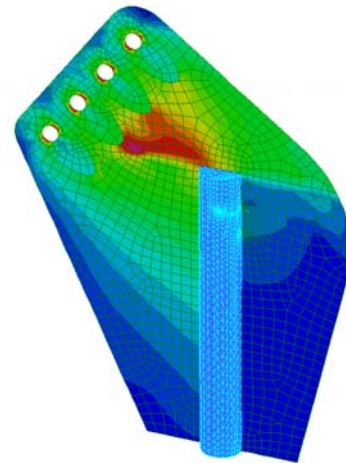
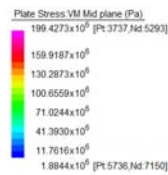
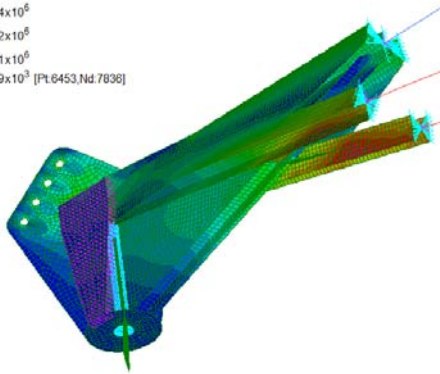
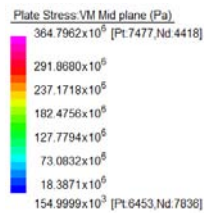

Graphic representation of stresses

### 3 Wind tunnel tests

The design has been assisted by experimental testing procedures in boundary wind tunnel laboratories by manufacturing of a rigid aerodynamic model of the roof and of the stadium in a geometrical scale factor equal to 1/100 according to the drawings. Models have been designed in order to allow the measurement of the overall forces through a couple of six-components force-balances and 4 load cells and of the surface pressure in discrete points through pressure taps (548 points over the roof and the lateral shield) ([1])

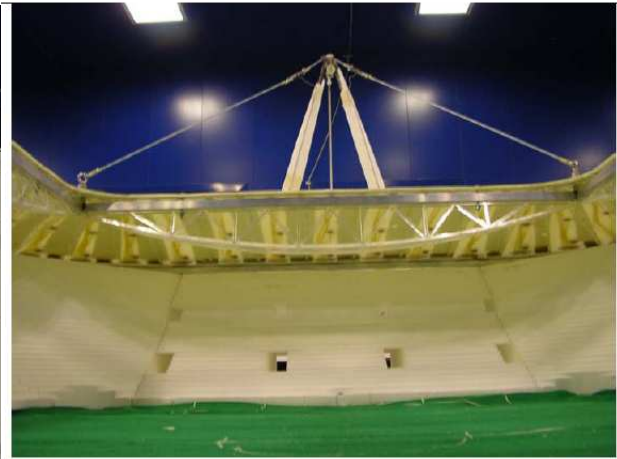
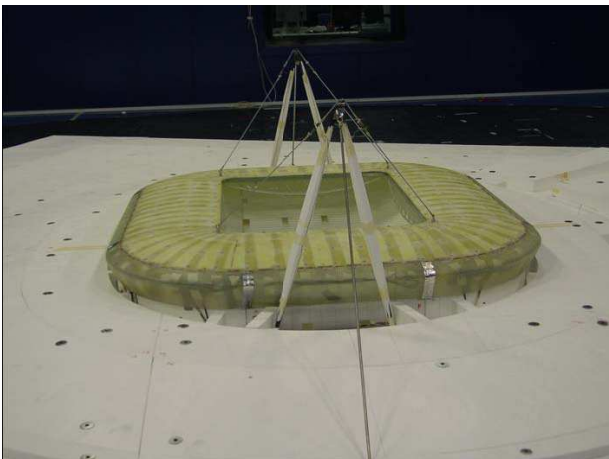



The goals are:

- Measurement of the external and internal surface pressure on the roof and on the external surface of the lateral shield for 12 wind exposures and 3 values of the incoming wind speed.
- Measurement of the overall forces and moments (on the roof) for 12 wind exposures and 2 values of the incoming wind speed.
- The computation of the aerodynamic forces acting on 8 sections of the roof and of the lateral shield (performed by integrating the pressure distribution). The data analysis was carried out by splitting the whole roof (roof + lateral shield) into 8 sections according to the following figure.

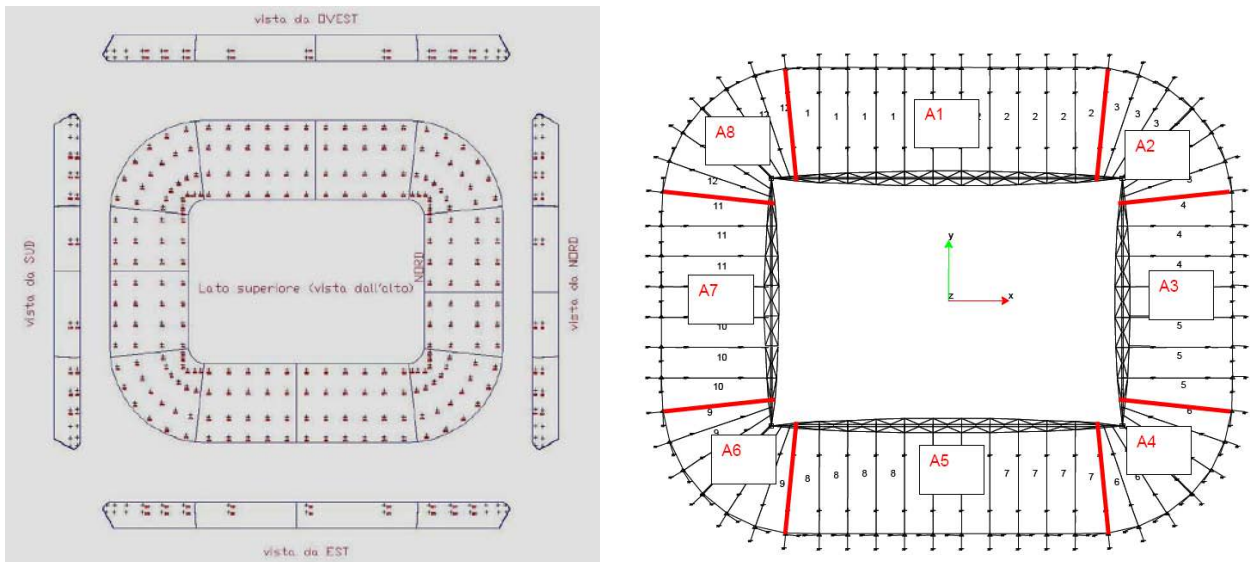

Another wind tunnel tests was carried out on an aeroelastic scaled model of a single leg of the stadium towers. The aim of the tests in the wind tunnel on the aeroelastic model was to verify the possible vortex shedding phenomena related to a single tower leg for different wind angles of attack.



#### 4 References

- [1] DIANA. G., RESTA F. - Politecnico di Milano – Dipartimento di Meccanica. “Svolgimento di prove in galleria del vento: progetto del nuovo Stadio Juventus”, 02/02/2008.
- [2] DIANA. G., RESTA F. - Politecnico di Milano – Dipartimento di Meccanica. “Aeroelastic behaviour of the stadium tower leg”, 08/06/2009.